

# ***G.I.KRAFT***

---

## **Owner's Manual**



**GI12116**

---

The equipment is approved by a number of car manufacturers



# Contents

---

|   |    |
|---|----|
| 1、 Safety Precautions Symbols .....       | 1  |
| 2、 Symbols and Definitions .....          | 2  |
| 3、 Accessories and Spare Parts List ..... | 3  |
| 4、 Installation                           |    |
| 1)、 Specifications .....                  | 4  |
| 2)、 Duty Cycle and Overheating.....       | 5  |
| 3)、 Machine Installation.....             | 6  |
| 4)、 Selecting a Location.....             | 7  |
| 5)、 Connecting Input Power .....          | 8  |
| 5、 Operation                              |    |
| 1)、 Controls.....                         | 9  |
| 2)、 Welding Gun and Adaptors.....         | 10 |
| 3)、 Various Operations                    |    |
| a、 Washer Welding .....                   | 11 |
| b、 Triangle Washer Welding.....           | 12 |
| c、 Carbon Rod Heating.....                | 13 |
| d、 Wave Form Wire Welding.....            | 14 |
| e、 Cupules .....                          | 15 |
| 6、 Maintenance                            |    |
| 1、 Exploded View .....                    | 16 |
| 2、 Troubleshooting.....                   | 17 |
| 7、 Electrical Diagram .....               | 18 |
| 8、 Packing List                           |    |

# Safety Precautions Symbols



Protect yourself and others from injury, read and follow these precautions before installation and operation.

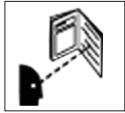

Read instructions.  
1. Read owner's Manual before using or servicing unit.  
2. Use only manufacturer's supplied replacement.



Electric shock can kill:  
1. Do not touch live electrical parts.  
2. Wear dry, hole-free insulating gloves and body protection.  
3. Do not wrap electrical cable around your body.  
4. Ground the workpiece with a good electrical ground.



Exploding parts can injure. Always wear a face shield and long sleeves.



Fumes and gases can be hazardous welding produces fumes and gases. Breathing these fumes and gases can be hazardous to your health. If inside, ventilate the area. Do not weld in a confined space only if it is well ventilated.



Static can damage PC boards  
1. Put on grounded wrist strap before handling boards or parts.  
2. Use proper static-proof bags and boxes to store, move or ship PC boards.

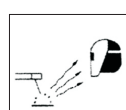

Eye protection for welding:  
Current level in amperage    Minimum shade  
Number  
30-150A----- #8  
150-300A----- #10  
300-500A----- #12



1. Wear approved face shield or safety goggles with side shields.  
2. Wear proper body protection to protect skin.



The heat from the workpiece can cause serious burns.



Flying metal can injure eyes.  
1)Wear safety glasses with side shields or face shield.



Remove all flammables of the welding area.



1. Magnetic fields can affect pacemakers. Pacemaker wearers keep away.  
2. Wearers should consult their doctor before going near plasma arc cutting operations.



Falling unit can cause injury.



Overuse can cause overheating  
Allow cooling period , follow rated duty cycle before starting to weld again.



Fire or explosion hazard.  
Do not locate unit on, over, or near combustible surfaces. Do not install unit near flammables.



Do not weld in the height!



Never cut on pressurized cylinder.



Protect yourself



Warn others



OK



OK

















Factory safety!



Maintenance regularly!

























# Definitions

## Symbols and Definitions

|   |  |   |   |
|---|--|---|---|
| <b>A</b><br>Amperes   | <b>I<sub>1max</sub></b> Rated maximum supply current   | <b>I</b><br>On  | <b>%</b><br>Percent   |
| <b>V</b><br>Volts   | <b>I<sub>1eff</sub></b> Maximum effective supply current   | <b>O</b><br>Off   |  Increase                |
| <b>I<sub>2</sub></b><br>Rated welding current                           | <b>IP</b> Degree of protection   |  Protective earth (Ground)             |  Line connection         |
| <b>S<sub>1</sub></b> Power rating, product of voltage and current (KVA) | <b>1~</b> Single phase   |  Do not do this                        |  Loose shield cup        |
| <b>HZ</b><br>Hertz  | <b>X</b> Duty cycle  |  Suitable for some hazardous locations |  Adjust air/gas pressure |
| <b>U<sub>1</sub></b> Primary voltage                                    |  Direct current   |  Input                                 |  Automatic               |
| <b>U<sub>0</sub></b> Rated no load voltage (Average)                    |  Constant current |  Voltage input                        |  Manual                  |
| <b>U<sub>2</sub></b> Conventional load voltage                          |  Temperature    |  Low air pressure light              |   |

# Accessories And Spare parts

## Accessories and Spare Parts List:

|   |                                     |   |  |   |   |
|---|-------------------------------------|---|--|---|---|
|  | Pneumatic vacuum cupule<br>NO. F001 |  | Pull hammer<br>NO. F002                |  | Vertical spot welding<br>pull hammer NO. F003 |
|  | Claw puller<br>NO. F004             |  | Hook<br>NO. F005                       |  | Wriggle<br>NO. F006                           |
|  | Carbon Cod<br>NO. F007              |  | Spot welding electrode<br>tip NO. F008 |  | Carbon rod adaptor<br>NO. F009                |
|  | Waveform electrode tip<br>NO. F010  |  | Washer adaptor<br>NO. F011             |  | Electrode holder<br>NO. F012                  |
|  | Trianger washer adaptor<br>NO. F013 |  | Front part of puller<br>NO. F014       |  | Triangle wasler<br>NO. F015                   |
|  | Stud<br>NO. F016                    |  | Washer<br>NO. F017                     |  | Ground wire clamp<br>NO. F018                 |
|  | Manual cupule<br>NO. F019           |  | Welding gun<br>NO. F020                |  | Front wheel<br>NO. F021                       |
|  | Back wheel<br>NO. F022              |  | Circuit board<br>NO. F028              |   |   |
|  | Control transformer<br>NO. F025     |   |  |   |   |











### Remark:

- 1)、Optionnal orders for above accessories and components are available.
- 2)、Model and parts number required when ordering parts from your local distributor.

# Installation

## 1、specifications

|                            |                             |                        |                    |
|----------------------------|-----------------------------|------------------------|--------------------|
| Input voltage              | 220V                        | 50/60Hz                |                    |
| Output voltage             | AC6V-10V Carbon rod heating | AC1V-12V Washer fusion | AC1V-13V Butt weld |
| Input power                | 10KW                        |                        |                    |
| Instant max. current       | 1200A                       |                        |                    |
| Input current              | 30A                         |                        |                    |
| Operation way              | Continuity                  |                        |                    |
| Time regulation system     | 0-99ms                      |                        |                    |
| Operation place            | Stepless                    |                        |                    |
| One side welding thickness | 0.8+1.2 (mm)                |                        |                    |
| Vacuum cupule device       | 180kg                       |                        |                    |
| Dimension                  | 460*480*1050 (mm)           |                        |                    |
| Weight                     | 35kg                        |                        |                    |

| Picture   | Description                    | Time (s) | Power |
|---|--------------------------------|----------|-------|
|  | Triangle washer welding        | 0.01-FFF | 25-FF |
|  | Washer welding                 | 0.01-FFF | 25-FF |
|  | OT washer welding              | 0.01-FFF | 25-FF |
|  | Stud welding                   | 0.01-FFF | 25-FF |
|  | Single-sided spot welding      | 0.01-FFF | 25-FF |
|  | Wavy wire welding              | 0.01-FFF | 25-FF |
|  | Sheet metal flattening         | FFF      | 25-FF |
|  | Carbon rod stitch welding      | FFF      | 25-FF |
|  | Carbon rod heating & shrinking | FFF      | 25-FF |
|  | Carbon rod cutting             | FFF      | 25-FF |

## 2、 Duty Cycle and Overheating

Duty cycle is percentage of 10 minutes that unit can weld at rated load without overheating.

If unit overheat, output stops , and cooling fan runs . Wait fifteen minutes for unit to cool. Reduce amperage or duty cycle before welding.

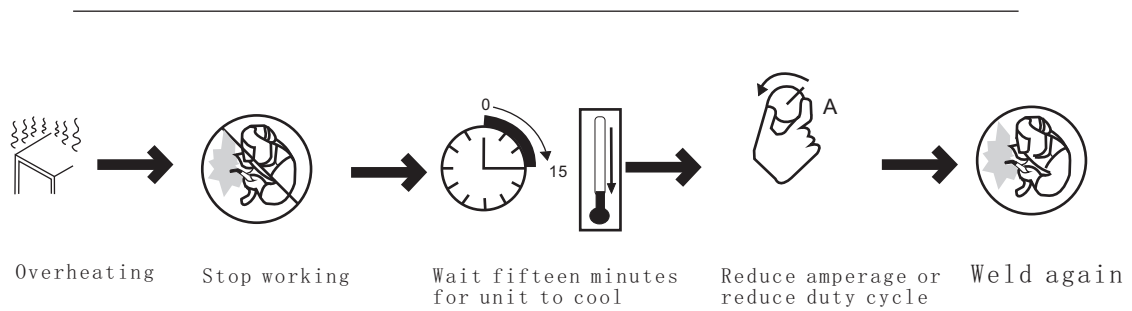

### 3. Machine Installation

- 1) Open the package and find out the owner's manual.
- 2) Check the supplied accessories according to packing list that attached to this manual.
- 3) Properly install this equipment as following diagram. Inspect the unit for any problems. If so, contact your local distributor or service agency. To locate a distributor or service agency.

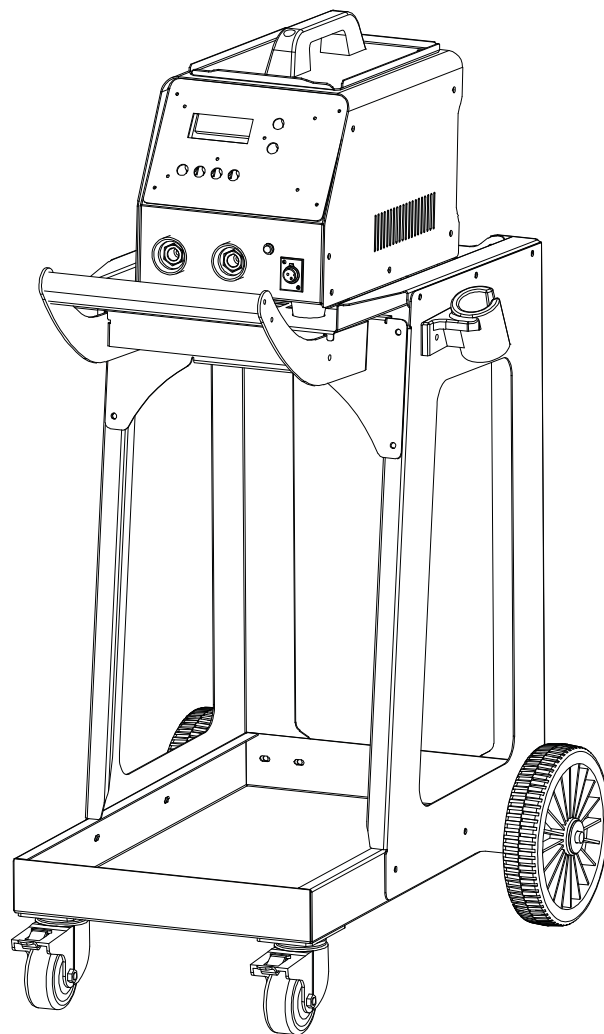



#### 4、 Selecting a Location

- 1) Select a correct location to place the unit.
- 2) Determine input power cord length according to its actual operation requirement . Make sure that the supply cable is at least 6mm<sup>2</sup> in diameter
- 3) Do not move or operate unit where it could tip.
- 4) Use cart or unit handle to move unit . Do not pull the cords to move unit.

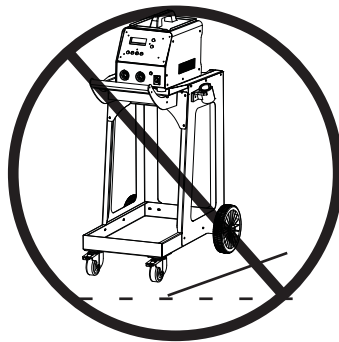
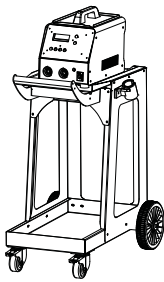

## 5、Connecting Input Power

The power supply must have a ground connection.  
The welder must also be connected to circuit breaker.

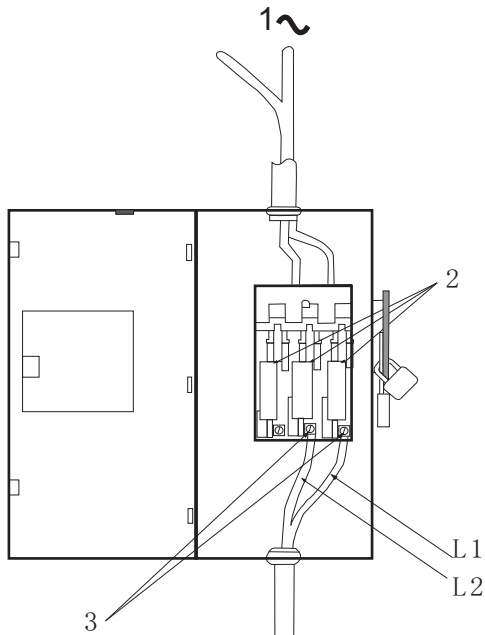

- 1、 Input power cord (not less than 6mm<sup>2</sup> copper cord) .
- 2、 Over-current protection.
- 3、 Disconnect device line terminals.
- 4、 Ground wire L1/L2 input conductors.

- Installation must meet all National and Local Codes---have only qualified persons make this installation.
- Disconnect and lockout/tagout input power before connecting input conductors from unit.
- Select type and size of over-current protection.
- Close and secure door on disconnect device . Remove lockout/tagout device, and place switch in the "on" position.

The power supply must have a ground connection.  
The welder must also be connected to circuit breaker.

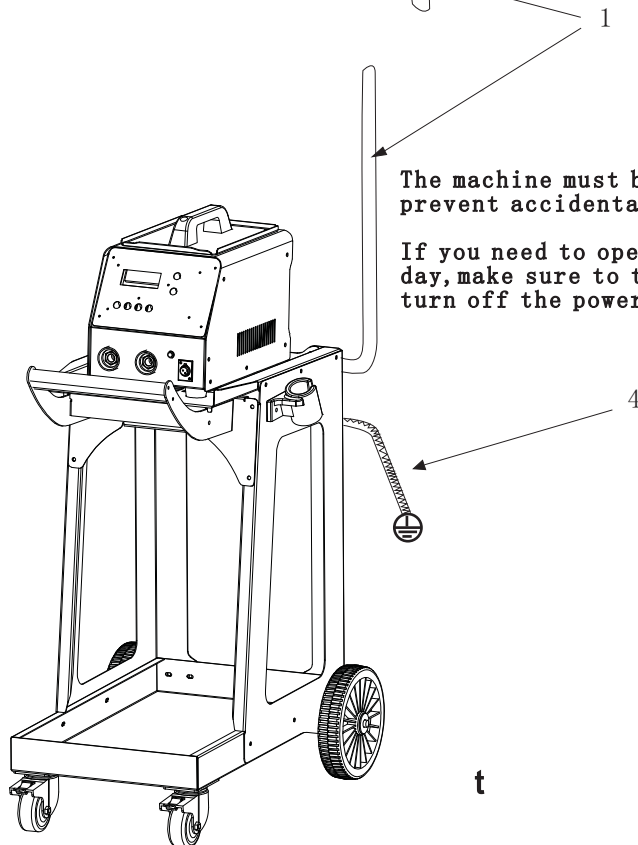

**The machine must be grounded(earthed) properly to prevent accidental electrical shock.**

**If you need to open the machine case(after work every day, make sure to turn off the external power source and turn off the power switch on the machine.**

# Operation

## 1、Controls

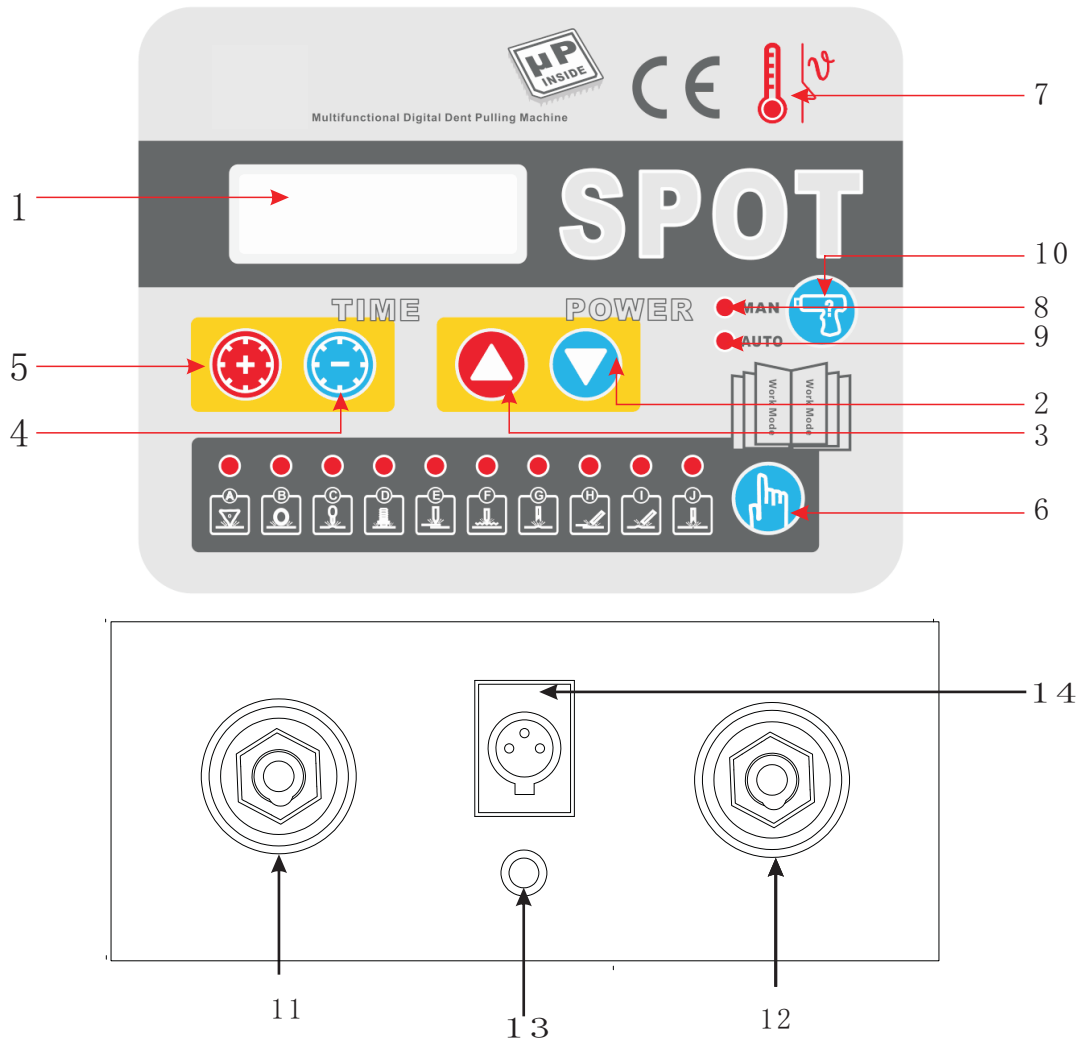

1. LCD Screen
2. Weld Power-- Down
3. Weld Power --Up
4. Weld Time---Down
5. Weld Time--Up
6. Weld Program Selection
7. Overheat Indicator
8. Manual Weld
9. Automatic Weld
10. Manual/Automatic Selection
11. Earth Cable Output
12. Weld Gun Cable Output
13. Gun Cable Trigger
14. Gun Cable Socket

### REMARK:

The programs G,H,I,J cannot be used in Automatic Weld. Weld Time cannot be set to FF(Full).In Automatic Weld, welding automatically without triggering.

-Pressing the two buttons “Weld Time—Up” and “Weld Program Selection” at the same to resume to default setting.

- Pressing the two buttons “Weld Power –Up” and “Manual/Automatic Selection” at the same time for switching English and Chinese

### Weld Program Selection:

Press quickly: Moving icon to the right

Press and hold: Moving icon to the left

## 2. Welding Gun and Adaptors

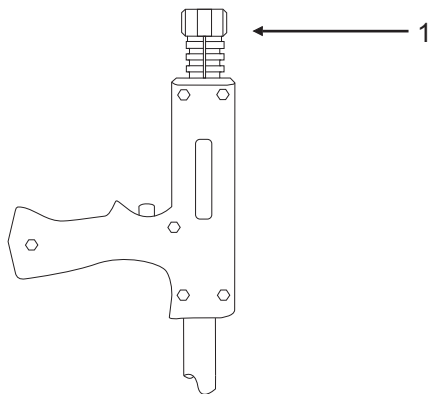

- 1, Electrode holder
- 2, Trigger

---

### Single-Sided applications

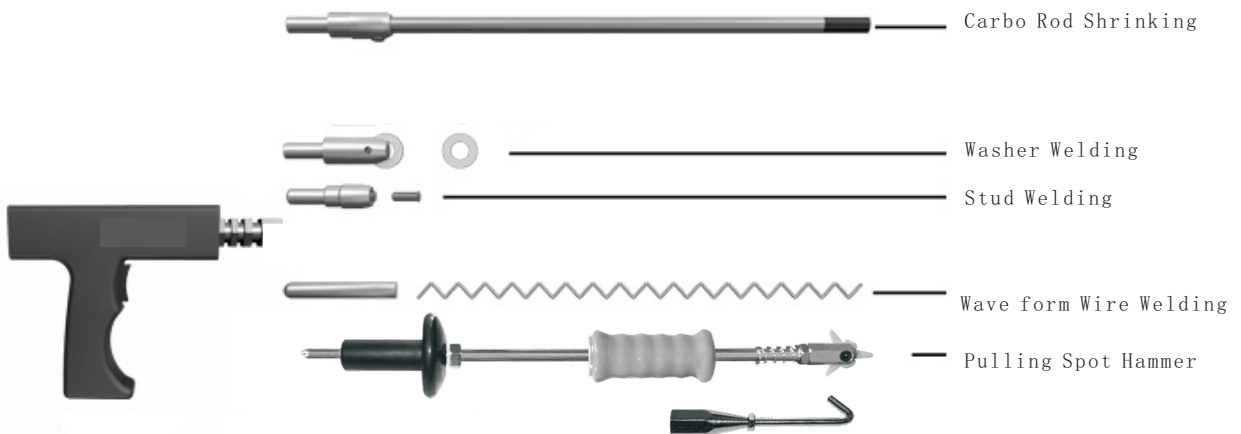

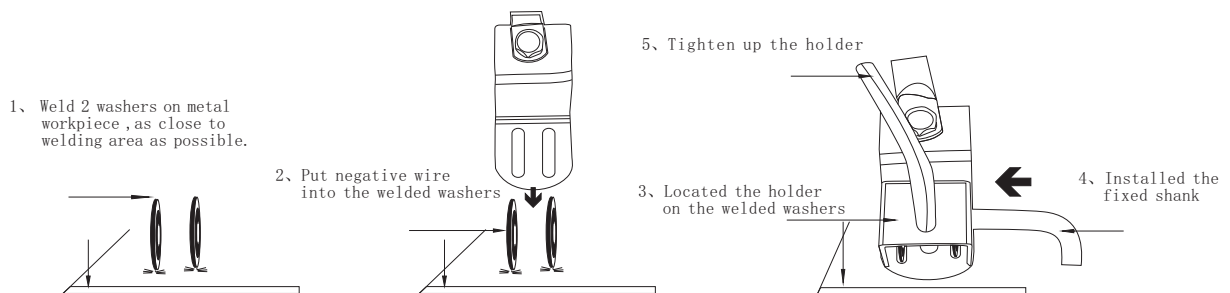

---

### Connection of negative wire

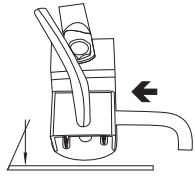

### 3、Operation

#### a、Washer Welding



Connect negative outside wire to a clean, paint-free location on metal workpiece, as close to welding area as possible.

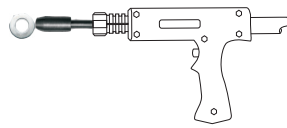

F017+F011+F020

Connect washer adaptor with welding gun and tighten, Install washer.

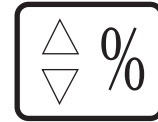

Set correct amperage.



Set correct time.

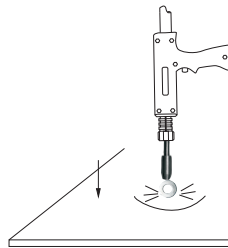

Approximately a 90° angle to the dent. Put on pressure and press trigger.

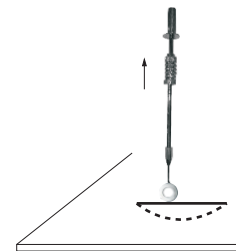

Remove welding gun. Hook the washer with pull hammer. Slide the hammer to opposite direction to pull out the dent.

#### Remark:

- 1、Setting amperage too high or time too long can cause workpiece surface (vehicle body) damage . Please weld other workpieces for practice before actual operations.
- 2、Setting correct amperage and time according to the workpiece thickness.
- 3、Continuing another operation is available after this procedure finished . if not, please shut off the main power supply and switch off the unit.

### 3、 Operation

#### b、 Triangle Washer Welding

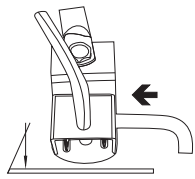

Connect negative outside wire to a clean, paint-free location on metal workpiece, as close to welding area as possible.

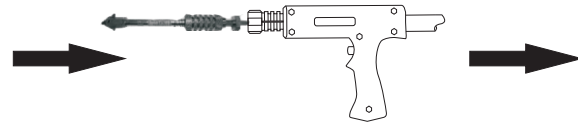

F003+F020

Connect triangle washer pull hammer with welding gun.



Set correct amperage.

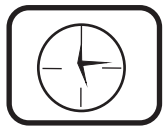

Set correct time.

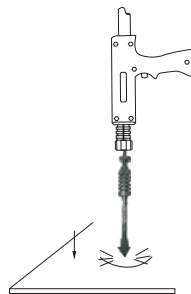

Approximately a 90° angle to the dent, put on pressure and press trigger.

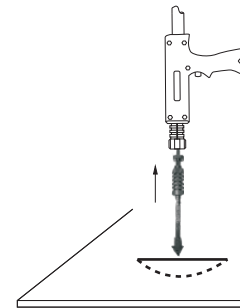

Slide the hammer to opposite direction to pull the dent out.

#### Remark:

- 1、 Setting amperage too high or time too long can cause workpiece surface (vehicle body) damage . Please weld other workpieces for practice before actual operations.
- 2、 Setting correct amperage and time according to the workpiece thickness
- 3、 Triangle washer welding can replace washer welding. It can pull out the dent directly after welded.
- 4、 Continuing another operation is available after this procedure finished .If not, please shut off the main power supply and switch off the unit.

### 3、Operation

#### C、Carbon rod Heating

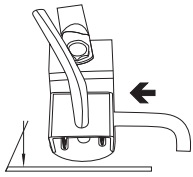

Connect negative outside wire to a clean, paint-free location on metal workpiece, as close to welding area as possible.

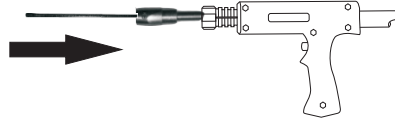

F007+F009+F020

Connect carbon rod and carbon rod adaptor with welding gun.



Set correct amperage.



Set correct time.

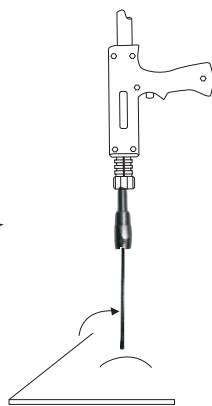

Carbon rod turning in clockwise to heat up the stretched panel

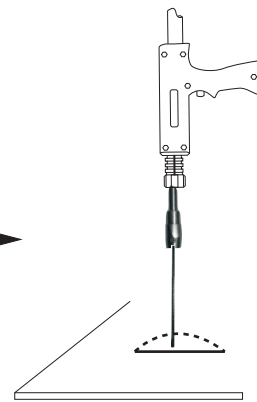

Use cold water or wet rag to cool down the heated area that makes the stretched panel shrunken as normal status.

#### Remark:

- 1、Setting amperage too high or time too long can cause workpiece surface (vehicle body) damage . Please weld other workpieces for practice before actual operations.
- 2、Setting correct amperage and time according to the workpiece thickness.
- 3、Continuing another operation is available after this procedure finished . If not, please shut off the main power supply and switch off the unit..

### 3、Operation

#### d、Wriggle Form Wire Welding

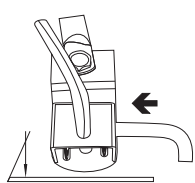

Connect negative outside wire to a clean, paint-free location on metal workpiece, as close to welding area as possible.

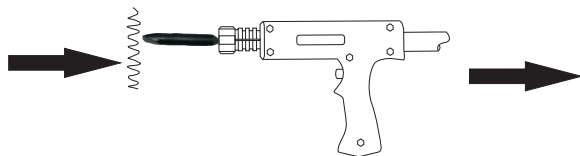

F006+F010+020

Connect wriggle wire electrode tip with welding gun.



Set correct amperage.

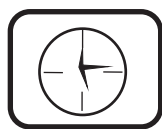

Set correct time.

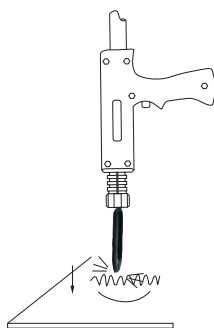

Place a wave form wire horizontally on the dent. Approximately a 90° angle to wave form wire. Put on pressure and press trigger.

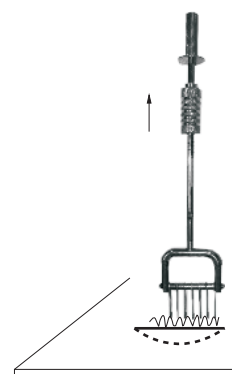

Connect hook puller with pull hammer. Hook wave form wire and slide the hammer to pull out the dent.

#### Remark:

- 1、Setting amperage too high or time too long can cause workpiece surface (vehicle body) damage . Please weld other workpieces for practice before actual operations.
- 2、Setting correct amperage and time according to the workpiece thickness.
- 3、Continuing another operation is available after this procedure finished . If not , please shut off the main power supply and switch off the unit.



### 3、 Operation

#### e、 Cupules

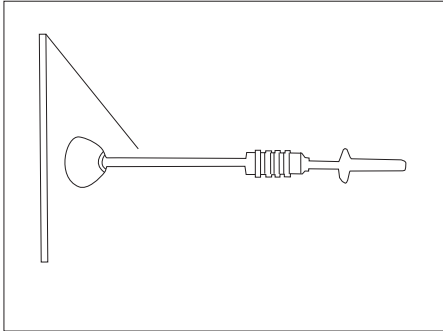

##### Manual operating cupule:

- 1、 Connect manual cupule with pull hammer.
- 2、 Push manual cupule in to lock the cupule on the dent.
- 3、 Slide the hammer to opposite direction to pull the dent out.

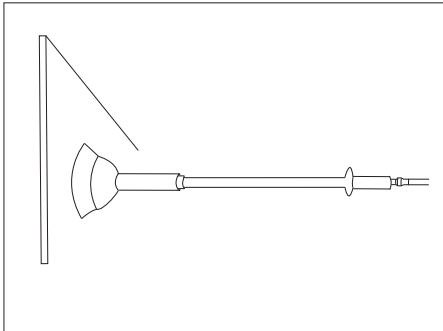

##### Pneumatic vacuum cupule:

- 1、 Connect gas/air supply with the adaptor of cupule.
- 2、 Open the valve , sticking cupule to the dent.
- 3、 Slide the hammer to opposite direction pull the dent out.
- 4、 Cupule falls off when close the valve.

# Maintenance

## 1. Exploded view

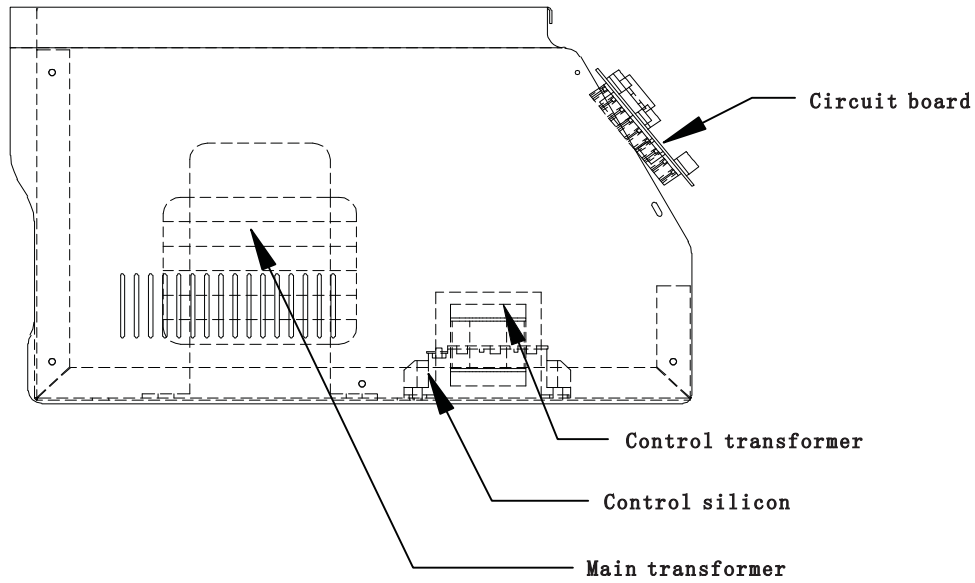

Left side view

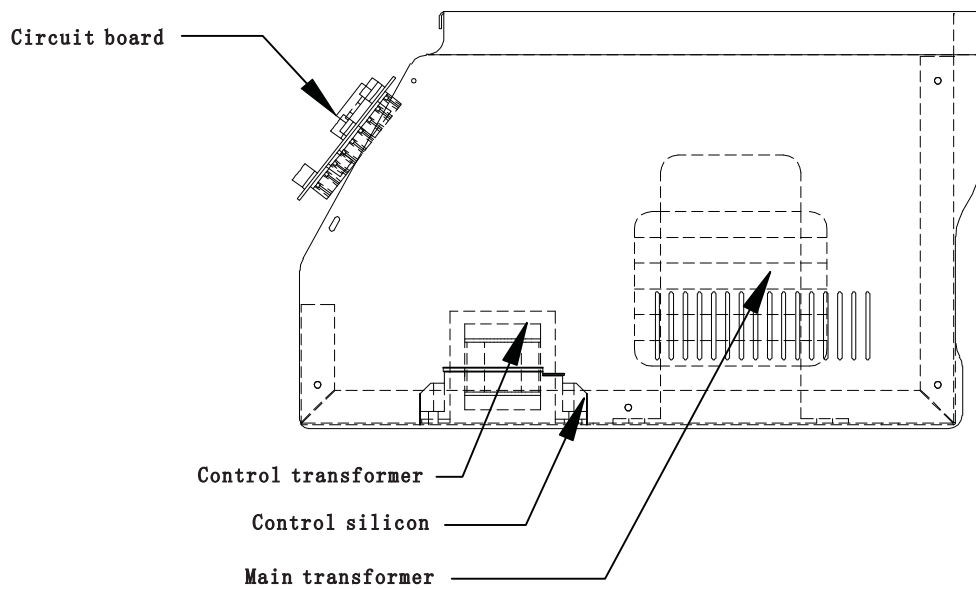

Right side view

# Maintenance

## 2、Troubleshooting

| Trouble                           | Reason  | Remedy   |
|-----------------------------------|---|--|
| No welding output                 | (1) Connected power supply incorrectly.<br>(2) Power switch in off position   | (1) Connect power supply according to manufacturer's instructions.<br>(2) Place power switch in "on" position.   |
| Trigger not working               | (1) Trigger damaged.<br>(2) Gun control wire broken.<br>(3) Control wire plug loosen.<br>(4) Mode switch in incorrect position.           | (1) Replace trigger.<br>(2) Connect again or replace if necessary.<br>(3) Connect control wire plug again.<br>(4) Place Mode switch in correct position. |
| Poor weld                         | (1) Amperage too low .<br>(2) Weld time too short.<br>(3) Input power cord did not meet the requirement.<br>(4) Ground clamp bad contact. | (1) Increase amperage setting.<br>(2) Increase time setting.<br>(3) Replace input power cord.<br>(4) Change ground clamp location.                       |
| Piercing workpiece                | (1) output amperage too high.<br>(2) Weld time too long.<br>(3) Bad contact of electrode tip or washer with workpiece.                    | (1) Reduce amperage setting.<br>(2) Reduce weld time.<br>(3) Remove coating from material reduce added pressure.   |
| Carbon rod working unstable       | (1) Carbon rod or workpiece is dirty<br>(2) Incorrect amperage and time setting.  | (1) Polish carbon rod and workpieces<br>(2) Set amperage and time according to workpiece thickness.  |
| Unit stop working while operation | (1) Trigger plug loosen.<br>(2) Gun control wire broken.<br>(3) Over heating.   | (1) Check gun control wire and trigger plug.<br>(2) Wait for temperature cool down.  |
|                                   |   |  |

# Installation

1. Fasten the bottom tray (1) and right and left side panels (2) together with screws.
2. Fasten the middle tray (3) in by screwing on the right and left side panels (2)
3. Fasten the top tray (4) in by screwing on the right and left side panels (2)
4. Fasten the handle (5) at each end with screws.
5. Fasten the hammer holder (6) and tool holder (7) to the right and left side panels (2).
6. Install the base plate (8) beneath the bottom tray (1). Finally, install the wheels (9) and casters (10).

